

# Investigation of prototype membrane based energy exchanger

Maria Justo Alonso, Hans Martin Mathisen, Sofie Aarnes



The Research Centre on  
Zero Emission Buildings

A world where buildings do not contribute with  
greenhouse gas emissions



# Background ZEB

---

Net Zero Energy Buildings aim at reducing energy needs through technology measures, using efficient energy supply systems; and substituting non environmental-friendly sources

- Study focused on **NZEB apartment** placed in **Nordic countries**
- Common ventilation system for all the apartments within a given building.
- The requirements for an ideal air-to-air energy exchanger for use in

NZEBs in Nordic countries are:

- **high effectiveness and efficiency,**
- **proper IAQ** and **avoid odours** spreading.

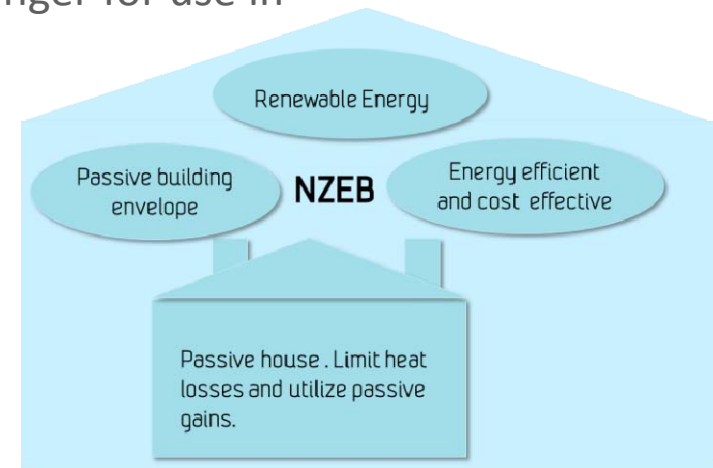

# Common Recovery Systems

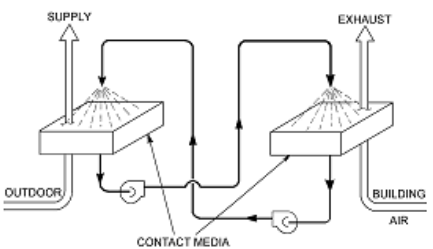
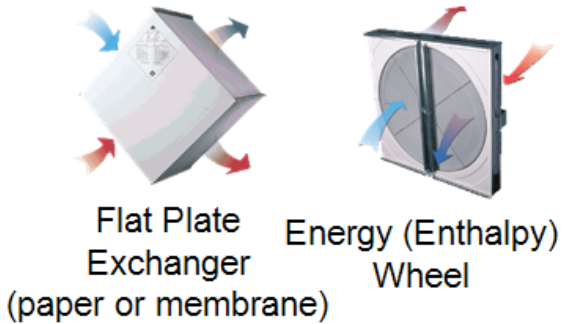

**Research Stage:**  
Run-around,  
Membrane  
Energy  
Exchanger  
(RAMEE)

Twin-Tower Enthalpy Recovery Loop

2004 ASHRAE Handbook—HVAC systems and equipment handbook. © American Society of Heating, Refrigerating and Air-Conditioning Engineers, Inc.

**Energy Exchange – Adjacent Duct**

**Energy Exchange – Non-adjacent Duct**

**Heat Exchange – Adjacent Duct**

**Heat Exchange – Non-adjacent Duct**

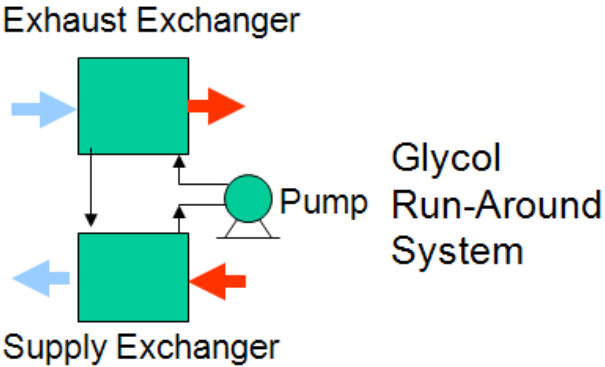

Most common types for residential ventilation

# Heat wheels

---

- + High efficiency
- + No or small frost problems
- + Easy to control
- **Transfer of odors from exhaust to fresh supply air**

# Ventilation of flats

Odors can spread from one flat to all others



# Frosting

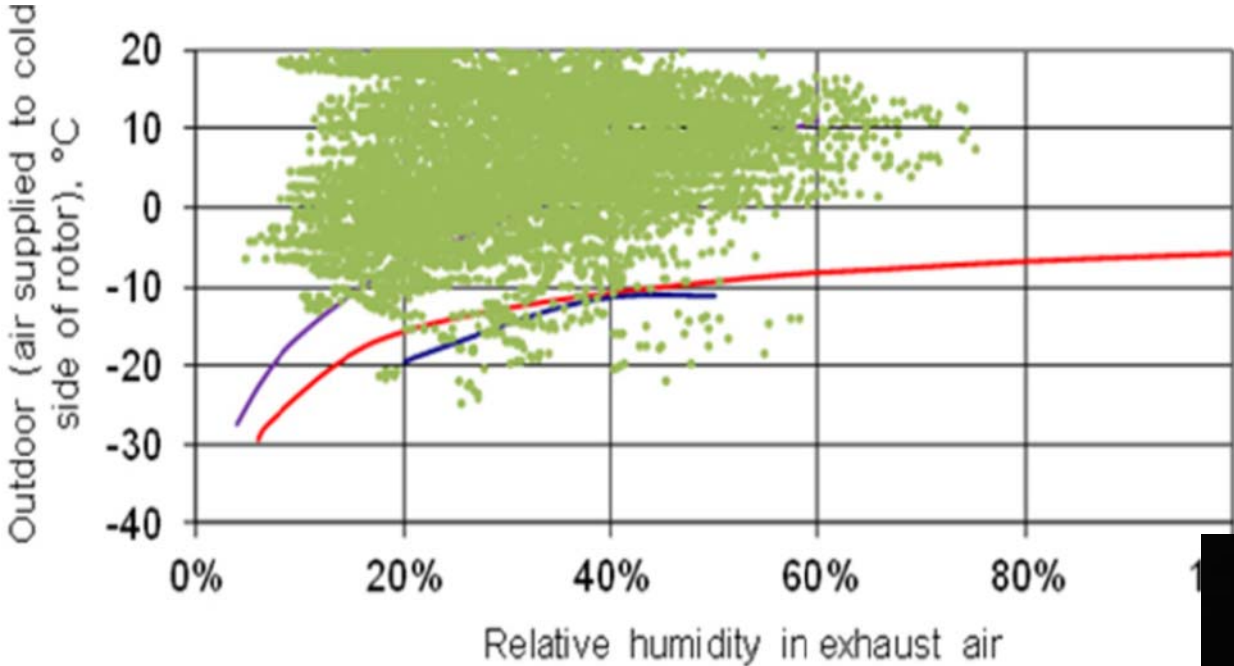

- RH, inlet on exhaust side of rotor
- Frost limit, Pfeiffer
- Frost limit, Holmberg
- Start condensing/-frosting coldest part, 100 % RH outdoor air



The Research Centre on Zero Emission Buildings

A world where buildings do not contribute with greenhouse gas emissions



# Counterflow flat plate exchangers

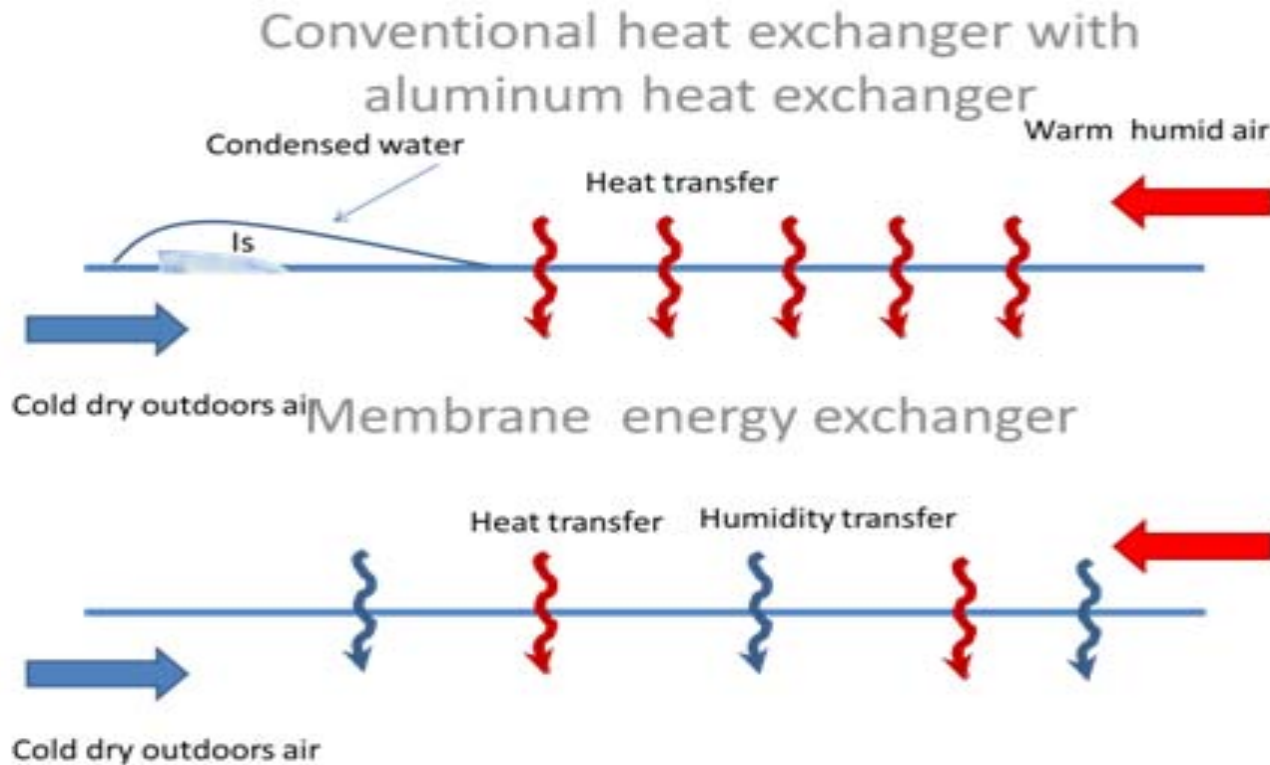

# Heat exchanger prototype

---

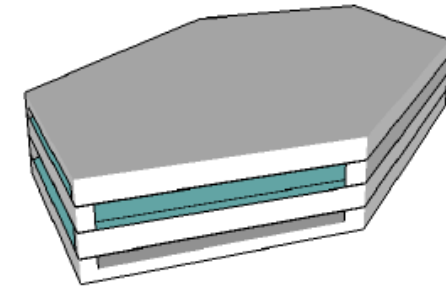
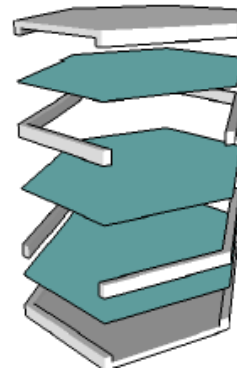
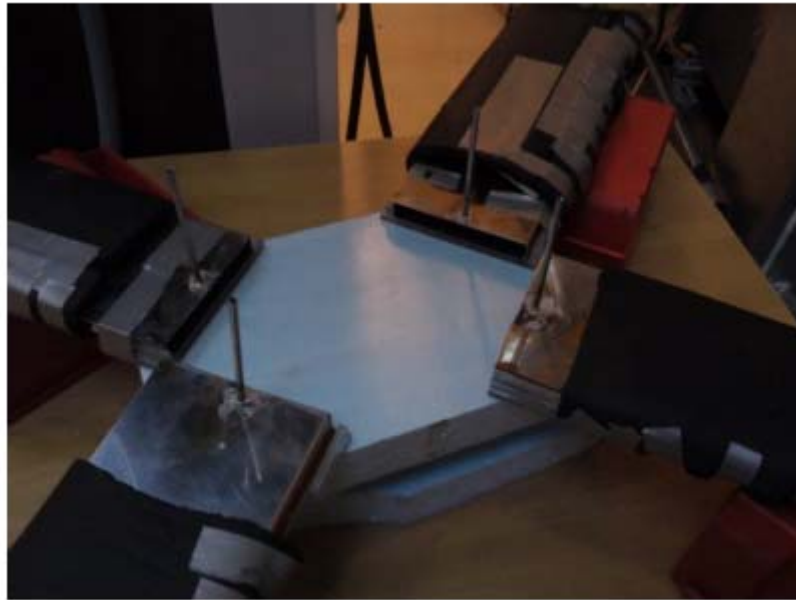

The Research Centre on  
Zero Emission Buildings

A world where buildings do not contribute with  
greenhouse gas emissions





# Experimental set up

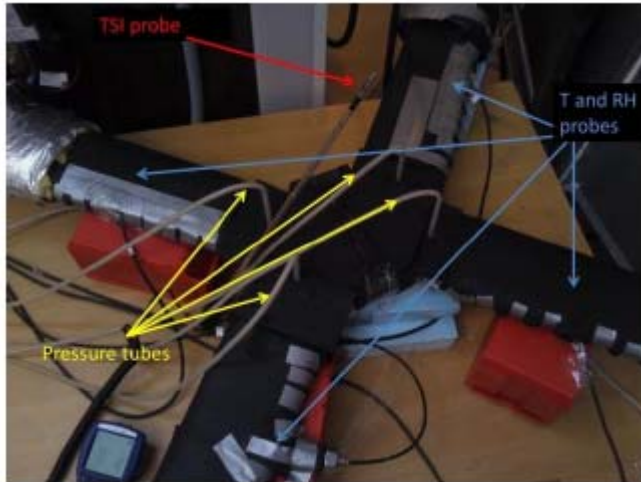

Properties for the different tested plate materials.

Material	Water permeable	Elastic	Crumples in high humidity
Wrapping plastic	No	No	No
PP (polypropylene)	No	yes	no
Membrane X	yes	yes	yes

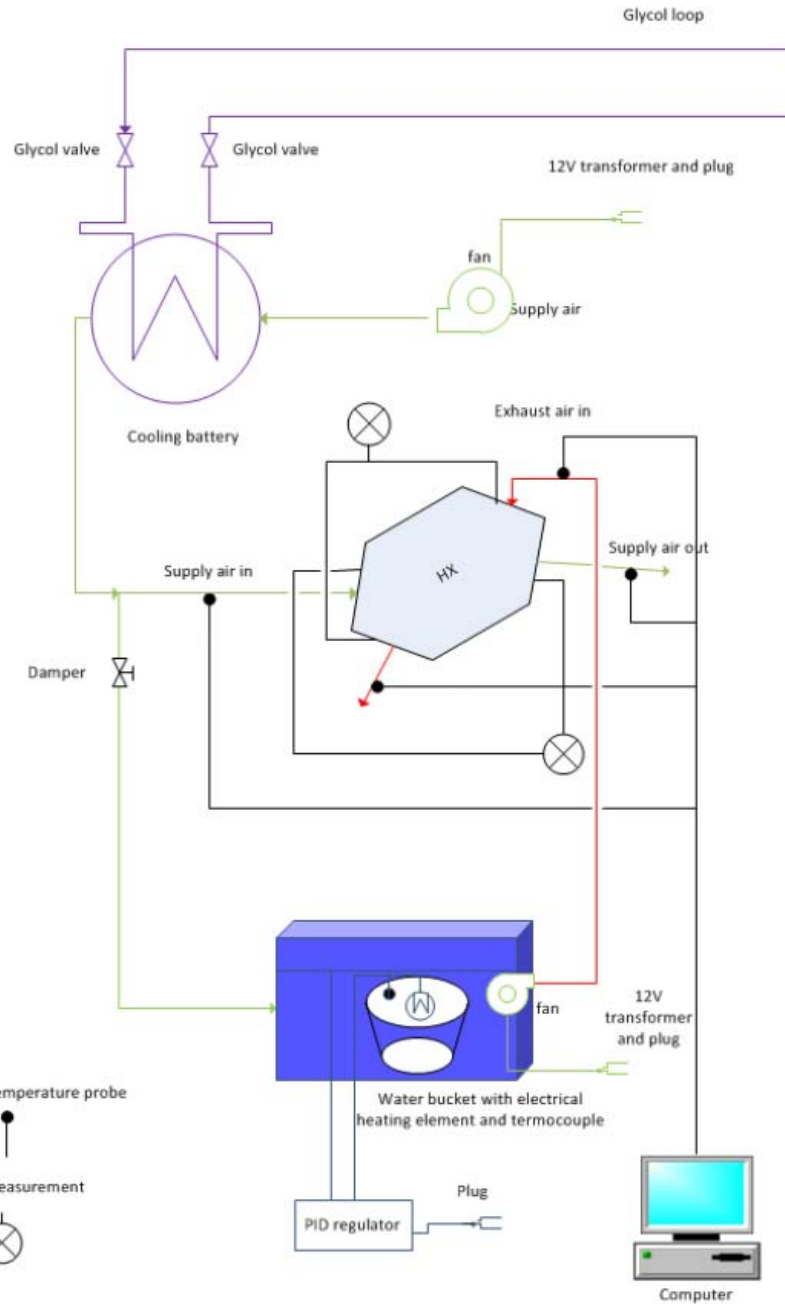

ribute with  
emissions



# Results

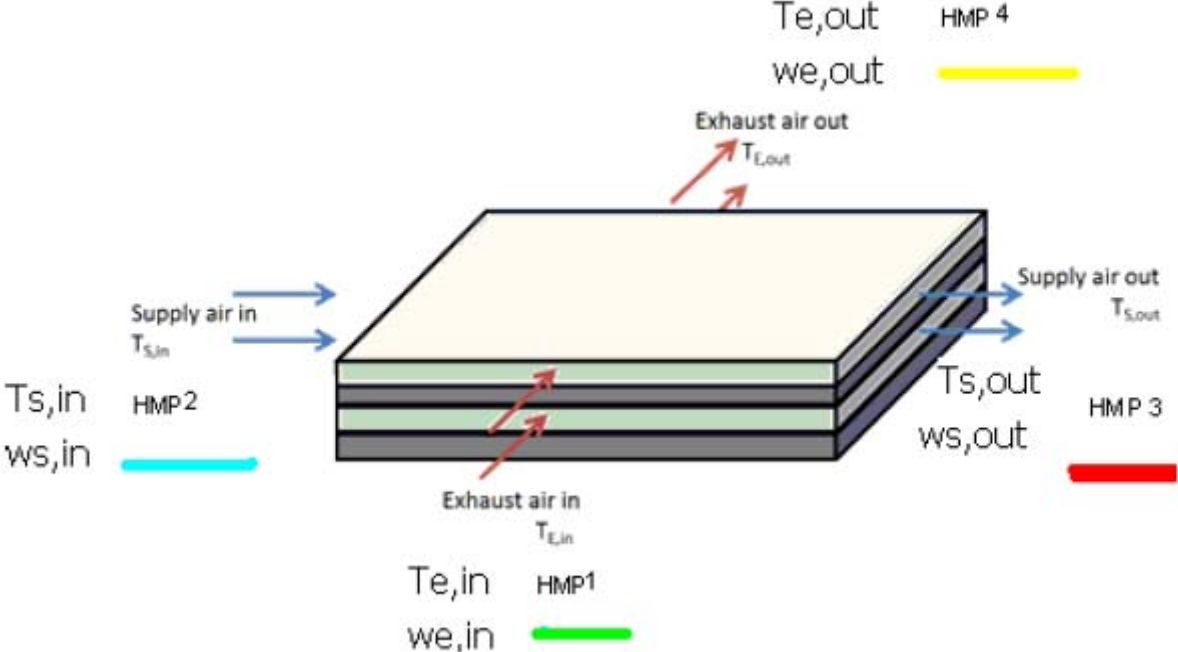

# Results

	Plate Material	$T_{s,in}(c)$	$T_{E,in}(c)$	$\Phi_{s,in}(\%)$	$\Phi_{E,in}(\%)$	$\Delta P_s$ [Patel]	$\Delta P_e$ [Patel]	$V_s(m^3/h)$	$V_e(m^3/h)$	$\eta_T$	$\eta_T$
	Wrap plastic	-5.27	1	27.4	43.6	2.4	2.55	1.58*	1.58	0.27	no moisture transfer
2	Wrap plastic	-8.05	20.85	33.6	39.3	3.95	5.79	1.66	1.05	0.37	no moisture transfer
3	Mem	-4.96	21.25	27.1	42.86	9.248	8.96	0.74	1.38	0.41	0.37
4	PP	-8.41	21.04	35.17	46.15	6.16	6.73	1.38	1.3	0.35	No moisture transfer
5	Mem	-0.23	22.91	39.02	45.25	10.47	9.85	1.53	1.33	0.54	0.49
6	Mem	-4.32	22.77	29.54	43.27	11.13	10.48	1.55	1.2	0.54	0.58
7	Mem	-10.5	23.21	41.04	37.27	27.19	25.6	2.6	0.6	0.6	0.91
8	Mem	-9.62	22.9	34.22	46.6	25.25	24.8	1.4*	0.6	0.61	0.88



The Research Centre on  
Zero Emission Buildings

A world where buildings do not contribute with  
greenhouse gas emissions



# Results

	Plate Material	$T_{s,in}(c)$	$T_{E,in}(c)$	$\Phi_{s,in}(\%)$	$\Phi_{E,in}(\%)$	$\Delta P_s$ [Patel]	$\Delta P_e$ [Patel]	$V_s(m^3/h)$	$V_e(m^3/h)$	$\eta_T$	$\eta_T$
	Wrap plastic	-5.27	1	27.4	43.6	2.4	2.55	1.58*	1.58	0.27	no moisture transfer
2	Wrap plastic	-8.05	20.85	33.6	39.3	3.95	5.79	1.66	1.05	0.37	no moisture transfer
3	Mem	-4.96	21.25	27.1	42.86	9.248	8.96	0.74	1.38	0.41	0.37
4	PP	-8.41	21.04	35.17	46.15	6.16	6.73	1.38	1.3	0.35	No moisture transfer
5	Mem	-0.23	22.91	39.02	45.25	10.47	9.85	1.53	1.33	0.54	0.49
6	Mem	-4.32	22.77	29.54	43.27	11.13	10.48	1.55	1.2	0.54	0.58
7	Mem	-10.5	23.21	41.04	37.27	27.19	25.6	2.6	0.6	0.6	0.91
8	Mem	-9.62	22.9	34.22	46.6	25.25	24.8	1.4*	0.6	0.61	0.88



The Research Centre on  
Zero Emission Buildings

A world where buildings do not contribute with  
greenhouse gas emissions



# Temperature efficiency for all experiments

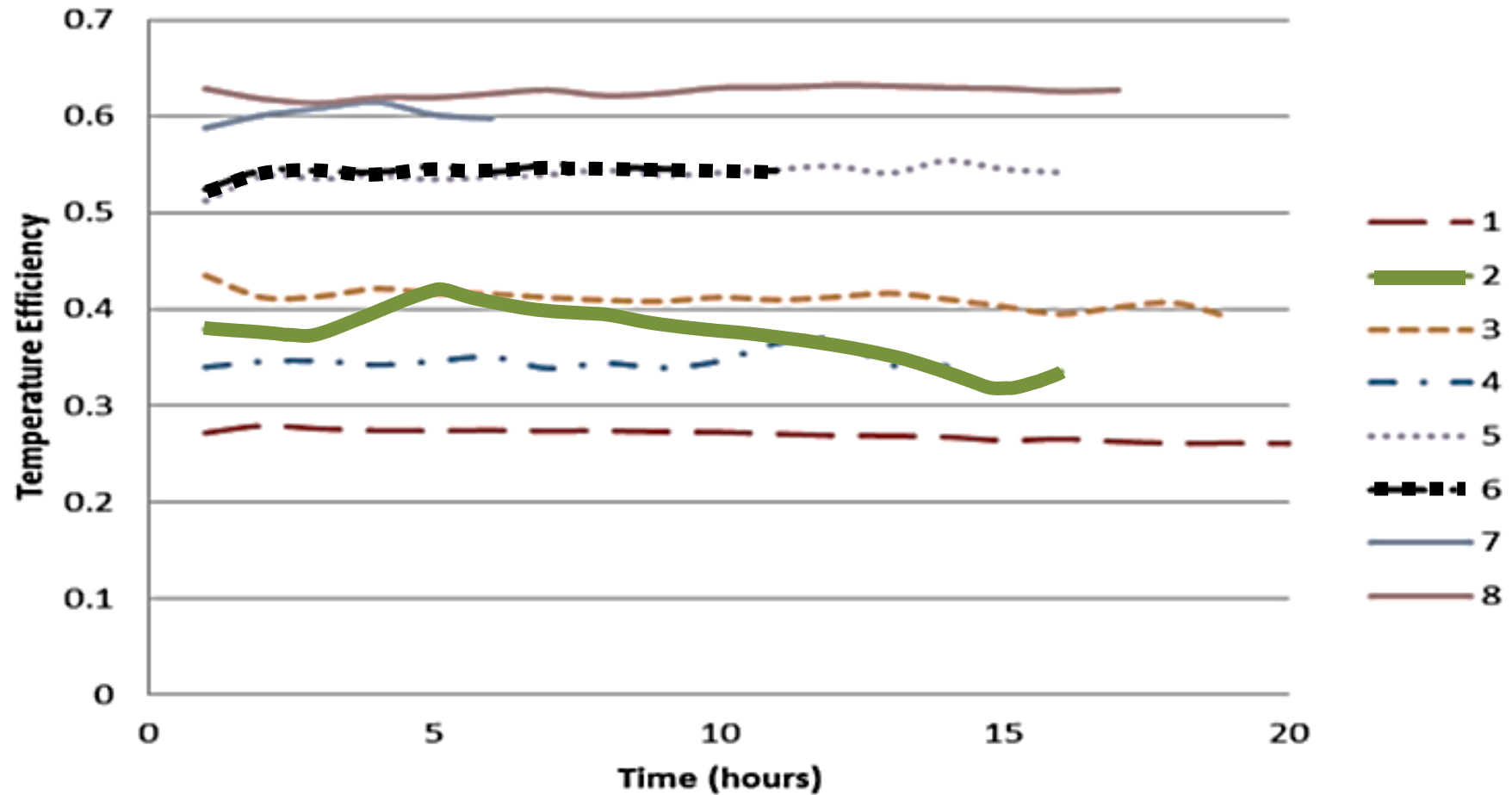

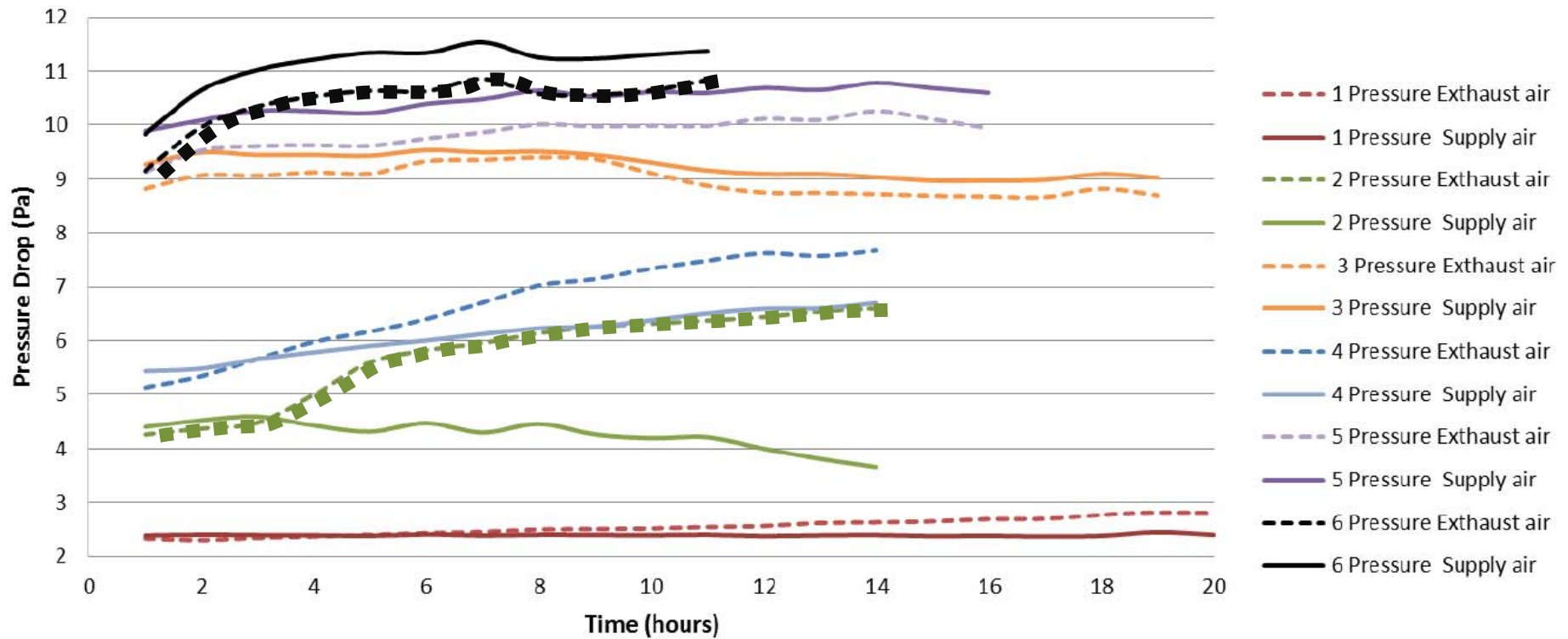

Pressure drop Experiments 1, 2 and 4 are plastic based while 3, 5, 6, 7, 8 are membrane based.

# Membrane crumpling

---

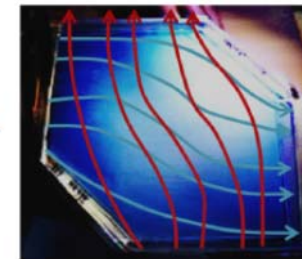
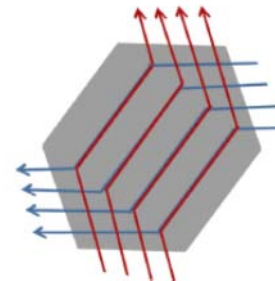
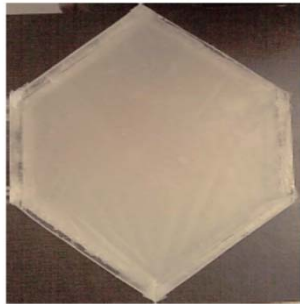
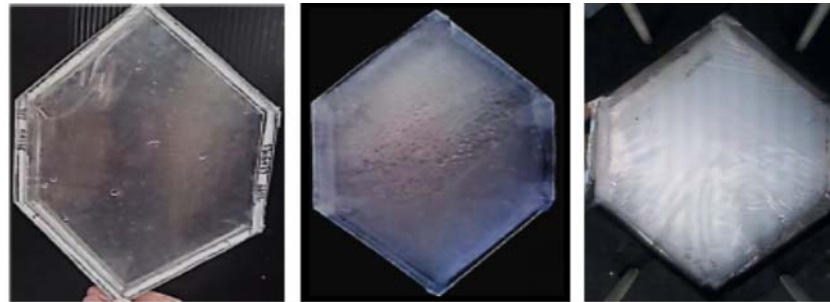

The Research Centre on  
Zero Emission Buildings

A world where buildings do not contribute with  
greenhouse gas emissions





# Conclusions

---

- Frost formation on plastic prototypes in exhaust channels near outdoor air inlet side of the exchanger.
- Not found in hydrophilic membrane. However, in exhaust air inlet humidity (46.6 % RH), the membrane expanded and crumpled.
- Hydrophilic membrane superior to the two plastic materials regarding
  - water condensation
  - frost formation
- Pressure drop strongly influenced by membrane elasticity and not proportional to flow rate.
- Other types of membranes should also be tested.
- Test at supply air temperature about -10 °C. Lower temperature performance should be investigated
- These tests should be repeated in a full-scale prototype to avoid scaling effects.
- Membranes should also be tested for durability and pollution transfer

# THANK YOU FOR YOUR ATTENTION



The Research Centre on  
Zero Emission Buildings

A world where buildings do not contribute with  
greenhouse gas emissions

